

# MI3 1M, 2M

Noncontact Temperature Measurement for Industrial Applications and OEMs



Raytek® MI3 – a new level of innovation and performance in noncontact temperature measurement

# MI3 1M, 2M Highlights

- Innovative multi-sensor design—up to 8 sensing heads/system, each individually addressable
- Fast response times of 10 mSec
- Standard laser target sighting
- Rugged IP65 rated sensing heads survive ambient temperatures to 120°C (248°F) without cooling
- Intuitive user interface with high resolution LCD display for easy set-up
- Precision high resolution 100:1 optics
- User configurable analog outputs (0/4-20mA, 0-5/10V, type J, K, R or S t/c)
- Standard USB 2.0 digital interface for remote set-up
- Optional network communications interfaces RS485, Modbus®, Profibus, Ethernet and Profinet analog all outputs with galvanic isolation (Analog DIN 6TE variant only):
  - from power supply
  - from channel to channel
- Isolated solid state alarm relay output
- Adjustable Emissivity, Peak Hold, Valley Hold and Averaging functions
- Datatemp® Multi-drop and field calibration software included
- Full range of accessories
- Automatic sensing head detection—plug and play
- Built in HTTP-Server and 64 MB data logger for communication boxes with Ethernet variant

The Raytek® MI3 is a powerful two-piece infrared temperature measurement system with miniature sensing head and separate communications electronics. The sensor is small enough to be installed just about anywhere, yet it outperforms much larger systems. Available in either a rugged cast metal electronics enclosure, an innovative multi-channel DIN mountable enclosure, or low cost OEM configurations, the MI3 offers a host of advanced signal processing features you won't normally find in sensors costing much more.

The MI3 features a variety of sensing head options. High temperature sensors with a measurement range of 250°C to 1800°C (482°F to 3272°F), fast response (10 mSec), 1.0, 1.6 µm spectral response sensors and laser sighted 100:1 optics provide an impressive solution for your process needs. The rugged stainless steel sensing head ensures reliable long term performance in the harshest industrial environments. Although the MI3 sensor is small in size, it has all the performance you need for the most demanding applications.

Standard features include adjustable Emissivity, Peak Hold, Valley Hold, and Averaging functions. All sensor parameters are easily adjustable on the built-in user interface keypad, or remotely with the Windows® 7 compatible DataTemp software via the built-in USB interface. Advanced features further extend the power of the MI3 and include user configurable alarm output, digital "recipe" table inputs that can be easily interfaced to an external control system, an external reset input for signal processing, and external inputs for analog emissivity adjustment or reflected energy compensation. Optional RS485, Modbus®, Profibus or Analog output network interfaces simplify intergration with a factory or machine control system.

The MI3's miniature size and low cost per measurement point make it ideal for installation at multiple points in your process. The MI3 is accurate, rugged, affordable, easy-to-install and operate. With the MI3, precision infrared temperature measurement is now an economical alternative.

*Raytek MI3 – a new level of innovation and performance in noncontact temperature measurement!*

# Specifications

Spectral Response:	
1M	1 µm
2M	1.6 µm
Optical Resolution:	
100:1 (1M/2M)	
Temperature Range:	
1M	500°C to 1800°C (932°F to 3272°F)
2M	250°C to 1400°C (482°F to 2552°F)
System Accuracy:	
Digital interface	±(0.5% of reading or 2°C) whichever is greater
mA/V output	±(0.5% of reading or 2°C) ±1°C
TC output	±(0.5% of reading or 2°C) ±1.5°C
System Repeatability:	
±0.25% of reading or ±1°C whichever is greater	
Temperature Resolution:	
0.1°C or 0.2°F *	
System Response Time:	
10ms (90%)	
Emissivity:	
0.100 to 1.100 digitally adjustable Increments of .001	
Transmission:	
0.100 to 1.000 digitally adjustable Increments of .001	
Signal Processing:	
Peak hold, valley hold, variable averaging filter, adjustable up to 998 seconds	

# Nominal Optical Specifications

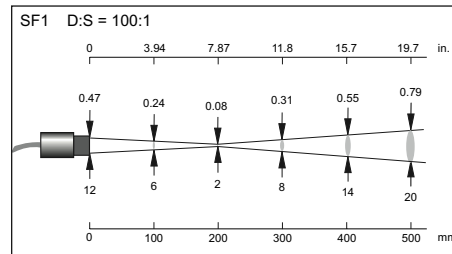

D:S is the optical resolution expressed as a ratio of the distance to the measurement spot divided by the diameter of the spot.

Optical resolution for the MI3 1M and MI3 2M is 100:1.

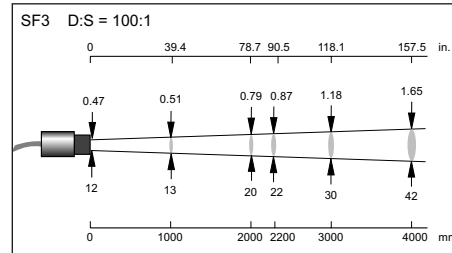

Nominal spot size based on 90% energy.

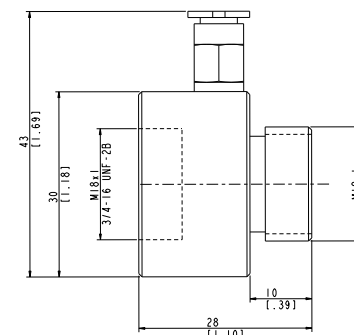

Air purge collar

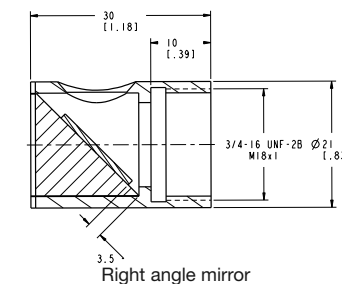

Right angle mirror

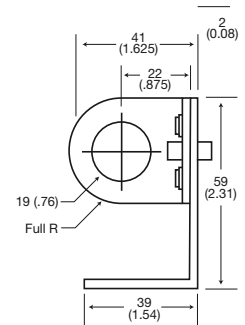

Adjustable Mounting Bracket

# Electrical Specifications MI3COMM

Digital Interface	USB 2.0 (RS485, Modbus, Profibus, Ethernet and Profinet optional)
Outputs:	Scaleable 4-20mA, 0-20mA, 0-10V, 0-5V, J, K, R or S thermocouple, 0-5V head ambient output
Inputs:	Digital inputs for emissivity control, ambient background temperature compensation, trigger/hold input
Alarm Relay:	48 VAC, 300 mA, optically isolated solid state relay
Cable Length*:	1m (3.3ft) standard 3m (10ft), 8m (26ft) and 15m (50ft) optional
Output Impedance (T/C output):	20 ohms
Minimum Load Impedance (mV output):	10K ohms
Maximum Loop Impedance (mV output):	500 ohms
Power Draw:	4W max
Power Supply:	8-32VDC
Environmental Rating:	IP 65 (NEMA-4)
Electronics Housing:	-10°C to 65°C (14°F to 150°F)
Storage Temperature:	-20°C to 85°C (-4°F to 185°F)
Relative Humidity:	10 to 95%, non-condensing
Electronics Weight:	270g (9.5oz)
EMI/EMC/ESD	IEC EN61326-1 1:2006

\*Maximum total cable length of 30 m (98 ft) when used with XXXMI3CONNBOX Multichannel interface box

# Electrical Specifications MI3MCOMM

Sensor Head Inputs	Maximum of 4
Digital Interface	USB 2.0 and RS485 standard. (Modbus, Profibus, Ethernet and Profinet optional)
Outputs	Scaleable 4-20mA, 0-20mA, 0-10V, 0-5V, J, K, R or S thermocouple, 0-5V head ambient output galvanic isolation
(Analog MI3MCOMM Box)	
Inputs:	Trigger input
Alarm Relay:	48 VAC, 300 mA, optically isolated
Cable Length*:	1m (3.3ft) standard 3m (10ft), 8m (26ft) and 15m (50ft) optional
Power Draw:	4W max
Power Supply:	8-32VDC
Electronics Housing:	-10°C to 65°C (14°F to 150°F)
Storage Temperature:	-20°C to 85°C (-4°F to 185°F)
Relative Humidity:	10 to 95%, non-condensing

\*Maximum total cable length of 60m (197ft)

# Sensing Head Specifications

Environmental Rating:	IP 65 (NEMA-4)
Head Ambient Temperature Range:	-10°C to 120°C (14°F to 248°F)
1M and 2M models:	-20°C to 85°C (-4°F to 185°F)
Storage Temperature:	-20°C to 85°C (-4°F to 185°F)
Relative Humidity:	10 to 95%, non-condensing
Construction:	
Sensing head	Stainless steel
Comm box (MI3)	Zinc, die-cast
DIN Comm box (MI3M)	Molded plastic
Sensing head cable	PUR halogen free, flame retardant insulation, 125°C (257°F) max. temp
Weight:	
Sensing head (w/3m cable)	240g (8.5oz)
Shock (sensing head)	IEC 68-2-27 50g's, 11ms, 3 axis
Vibration (sensing head)	68-2-6 3g's, 10-150Hz, 3 axis
EMI/EMC/ESD	IEC EN61326-1 1:2006

# Accessories

A full range of accessories for various applications and industrial environments are available. Accessories include items that may be ordered at any time and added on-site:

- (XXXSYSPS) 24 VDC, 1.2A Power supply
- (XXXMI3100FB) Fixed mounting bracket
- (XXXMI3100ADJB) Adjustable mounting bracket
- (XXXMI3100MN) Sensor head mounting nuts (2)
- (XXXMI3100AP) Air purge collar
- (XXXMI3100WS) Water Cooled Housing option allows the MI3 1M, 2M sensing heads to be used in ambient temperatures up to 180°C (356°F).
- (XXXMI3100RAM) Right angle mirror
- (XXXMI3CONNBOX) Multi-channel sensor interface box for use with MI3COMM Box
- (XXXUSB485) USB/RS485 Adapter for boxes with RS485 interface

# Sensor Dimensions

Sensing Head

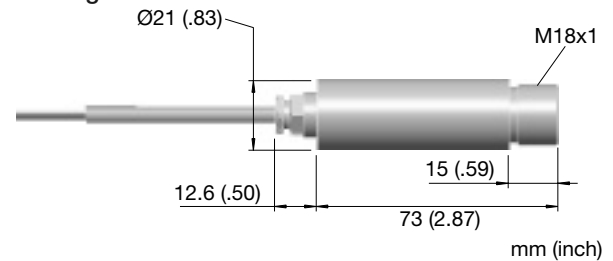

MI3 Electronics Housing

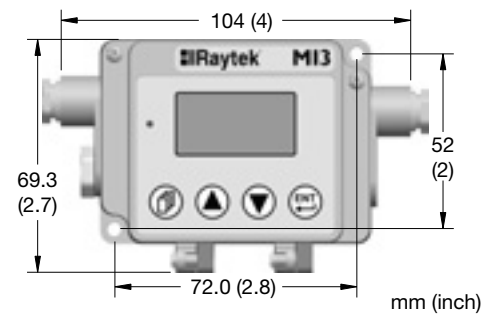

MI3M Multi-channel Electronics Housing

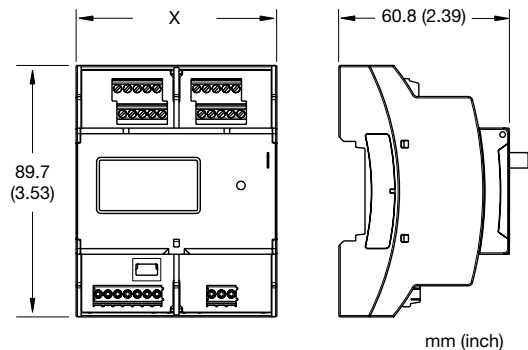

X Dimension

Models

54 mm (2.1 in)	RAYMI3MCOMMN
72 mm (2.8 in)	RAYMI3MCOMM
108 mm (4.3 in)	All other models

## Sensing Heads

RAYMI3

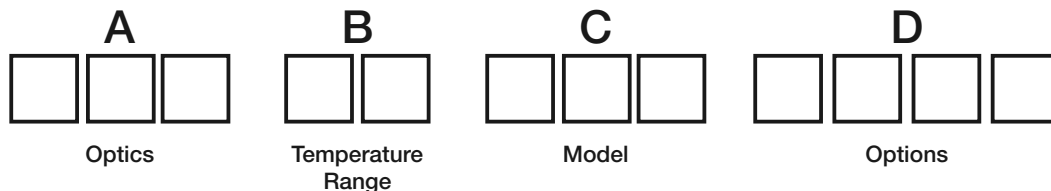

Each MI3 sensor system is comprised of (1) MI3 sensing head and (1) MI3COMM or MI3MCOMM communication module. The sensing head includes one mounting nut and 1m (3.3ft) cable. Longer cables up to 15 m (50ft) maximum are available and must be specified at time of order. The MI3 sensing head and MI3COMM box are ordered as separate items.

Model	Description
RAYMI3	Miniature infrared sensing head with 1m (3.3ft) cable
<b>Code A Optical Resolution</b>	
100	100:1
<b>Code B Temperature Range</b>	
1M	500°C to 1800°C (932°F to 3272°F)
2M	250°C to 1400°C (482°F to 2552°F)
<b>Code C Optical Focus</b>	
SF1	200mm focus distance
SF3	2,200mm focus distance
<b>Code D Options</b>	
CB3	3m (10ft) cable
CB8	8m (26ft) cable
CB15	15m (50ft) cable

## Communication Boxes

Model	Description
RAYMI3COMM	MI3 IR thermometer communication box with USB 2.0 communications, cast zinc housing and user-interface
RAYMI3COMM4	MI3 IR thermometer communication box with USB 2.0 communications and RS-485 communication option, cast zinc housing and user-interface
RAYMI3COMM M	MI3 IR thermometer communication box with USB 2.0 communications and Modbus communication option, cast zinc housing and user-interface
RAYMI3COMM P	MI3 IR thermometer communication box with USB 2.0 communications and Profibus communication option, cast zinc housing and user-interface
RAYMI3MCOMM	Modular DIN mountable 4-channel IR communication box with user interface, USB 2.0 and RS485 communications
RAYMI3MCOMM M	Modular DIN mountable 4-channel IR communication box with user interface, USB 2.0 and Modbus communications
RAYMI3MCOMM P	Modular DIN mountable 4-channel IR communication box with user interface, USB 2.0 and Profibus communications
RAYMI3MCOMM N	Modular DIN mountable 4-channel IR communication box with no user interface, display or RS485 interface. Includes USB 2.0 and alarm relay, only
RAYMI3MCOMM A	Modular DIN mountable 4-channel IR communication box with user interface, USB 2.0 and 4 galvanic isolated analog outputs
RAYMI3COMM E	MI3 IR thermometer communication box with USB 2.0 communications and Ethernet communication and built in HTTP-Server option, cast zinc housing and user-interface
RAYMI3COMM P N	MI3 IR thermometer communication box with USB 2.0 communications and Profinet communication, cast zinc housing and user-interface
RAYMI3COMM E	Modular DIN mountable 4-channel IR communication box with user interface, USB 2.0 and Ethernet interface with built-in HTTP-Server.
RAYMI3MCOMM P N	Modular DIN mountable 4-channel IR communication box with user interface, USB 2.0 and Profinet interface.

## The Worldwide Leader in Noncontact Temperature Measurement

**Raytek Corporation**  
**Worldwide Headquarters**  
 Santa Cruz, CA USA  
 Tel: 1 800 227 8074 (USA and Canada, only)  
 1 831 458 3900  
[solutions@raytek.com](mailto:solutions@raytek.com)

**European Headquarters**  
 Berlin, Germany  
 Tel: 49 30 4 78 00 80  
[raytek@raytek.de](mailto:raytek@raytek.de)

**China Headquarters**  
 Beijing, China  
 Tel: 8610 6438 4691  
[info@raytek.com.cn](mailto:info@raytek.com.cn)

To find a Raytek office near you, please visit [www.raytek.com](http://www.raytek.com)

### Worldwide Service

Raytek offers services, including repair and calibration.  
 For more information, contact your local office or e-mail [support@raytek.com](mailto:support@raytek.com)

[www.raytek.com](http://www.raytek.com)



Raytek is an ISO 9001 certified company

© 2014 Raytek Corporation (4106811 Rev D) 2/2014  
 Raytek, the Raytek logo and DataTemp are registered trademarks of Raytek Corporation.  
 Modbus is a registered trademark of the Modbus Organization, Inc.  
 Specifications subject to change without notice.